

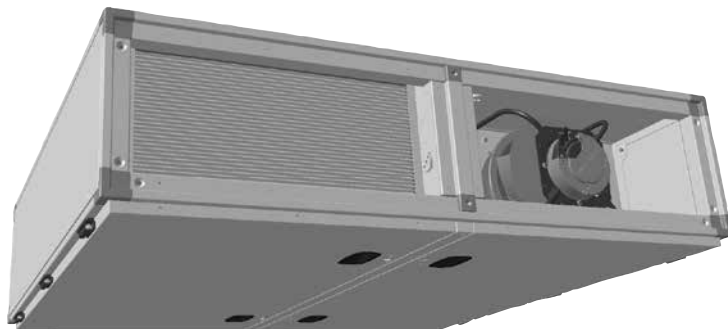





Schema zapojení větracího zařízení

Teplovodní registr CFL 32-WRG-PWW



0	1	2	3	4	5	6	7	8	9																																																																																																																								
F26_001_Wolf_Standard																																																																																																																																	
					WOLF GmbH Industriestraße 1 D-84048 Mainburg Tel. +49 (0)8751 74-0																																																																																																																												
<h1>Elektrotechnická dokumentace</h1>																																																																																																																																	
<table border="1" style="width: 100%; border-collapse: collapse;"> <tr> <td style="width: 30%; padding: 10px;">přístroj</td> <td style="padding: 10px;">CFL-32 PWW, PKW</td> </tr> <tr> <td style="padding: 10px;">Číslo výkresu</td> <td style="padding: 10px;">62-34-030-001</td> </tr> <tr> <td style="padding: 10px;">Vytvořeno dne</td> <td style="padding: 10px;">17.07.2014</td> </tr> <tr> <td style="padding: 10px;">Zpracováno dne</td> <td style="padding: 10px;">05.04.2017</td> </tr> <tr> <td style="padding: 10px;"></td> <td style="padding: 10px;">od (zkratka) Kür</td> </tr> <tr> <td style="padding: 10px;"></td> <td style="padding: 10px;">Počet stran 15</td> </tr> </table>										přístroj	CFL-32 PWW, PKW	Číslo výkresu	62-34-030-001	Vytvořeno dne	17.07.2014	Zpracováno dne	05.04.2017		od (zkratka) Kür		Počet stran 15																																																																																																												
přístroj	CFL-32 PWW, PKW																																																																																																																																
Číslo výkresu	62-34-030-001																																																																																																																																
Vytvořeno dne	17.07.2014																																																																																																																																
Zpracováno dne	05.04.2017																																																																																																																																
	od (zkratka) Kür																																																																																																																																
	Počet stran 15																																																																																																																																
<table border="1" style="width: 100%; border-collapse: collapse;"> <tr> <td style="width: 15%;"></td> <td style="width: 15%;">datum</td> <td style="width: 15%;">30.10.2014</td> <td style="width: 15%;">jednotka</td> <td style="width: 15%;">CFL-32</td> <td style="width: 15%;">PWW, PKW</td> <td style="width: 15%;"></td> <td style="width: 15%;"></td> <td style="width: 15%;"></td> <td style="width: 15%;"></td> </tr> <tr> <td></td> <td>zprac.</td> <td>EHM</td> <td></td> <td></td> <td></td> <td></td> <td></td> <td></td> <td></td> </tr> <tr> <td></td> <td>prezkoús</td> <td></td> <td></td> <td></td> <td></td> <td></td> <td></td> <td></td> <td></td> </tr> <tr> <td></td> <td>vznik</td> <td>62-34-030-001</td> <td></td> <td></td> <td></td> <td></td> <td></td> <td></td> <td></td> </tr> <tr> <td>změna</td> <td>jméno</td> <td></td> <td>nahrazen</td> <td></td> <td></td> <td></td> <td></td> <td></td> <td></td> </tr> <tr> <td></td> <td></td> <td></td> <td>nahrazen</td> <td></td> <td></td> <td></td> <td></td> <td></td> <td></td> </tr> <tr> <td colspan="8"></td> <td colspan="2" style="text-align: center;">Titulní strana</td> </tr> <tr> <td colspan="8"></td> <td colspan="2" style="text-align: center;">  </td> </tr> <tr> <td colspan="8"></td> <td colspan="2" style="text-align: center;"> 62-34-030-001 </td> </tr> <tr> <td colspan="8"></td> <td colspan="2" style="text-align: center;"> Odd.: TR EPLAN P8 2.6.3 Art.Nr. 3065175_CZ </td> </tr> <tr> <td colspan="8"></td> <td colspan="2" style="text-align: center;"> = + </td> </tr> <tr> <td colspan="8"></td> <td colspan="2" style="text-align: center;"> list od 15 listy </td> </tr> </table>											datum	30.10.2014	jednotka	CFL-32	PWW, PKW						zprac.	EHM									prezkoús										vznik	62-34-030-001								změna	jméno		nahrazen										nahrazen															Titulní strana																				62-34-030-001										Odd.: TR EPLAN P8 2.6.3 Art.Nr. 3065175_CZ										= +										list od 15 listy	
	datum	30.10.2014	jednotka	CFL-32	PWW, PKW																																																																																																																												
	zprac.	EHM																																																																																																																															
	prezkoús																																																																																																																																
	vznik	62-34-030-001																																																																																																																															
změna	jméno		nahrazen																																																																																																																														
			nahrazen																																																																																																																														
								Titulní strana																																																																																																																									
																																																																																																																																	
								62-34-030-001																																																																																																																									
								Odd.: TR EPLAN P8 2.6.3 Art.Nr. 3065175_CZ																																																																																																																									
								= +																																																																																																																									
								list od 15 listy																																																																																																																									

0	1	2	3	4	5	6	7	8	9
---	---	---	---	---	---	---	---	---	---

barvy připojovacích kabelů:

hlavní proudový obvod : černý
nulový vodič : světle modrý
ochranný vodič : žlutý/zelený
řídící okruh střídavého proudu : červený/ červenobílý
řídící okruh stejnosměrného proudu : tmavěmodrý/ tmavěmodrý/bílý
beznapětový kontakt (cizí napětí) : oranžový

POZOR!!

Před uvedením rozvaděče do provozu je třeba dodržet následující:

1. Všechny přípojky proveďte podle pokynů dodavatele energie
2. U všech spojovacích a kontaktních šroubů, jakož i neobsazených kontaktů je nutno zkontrolovat dotáhnutí (při transportu hrozí uvolnění)
3. Použité jističe motorů EC ventilátorů a el. registrů jsou využívány jako jističe vedení, nemusí být nastaveny na jmenovitý proud.
4. Síťové napětí porovnat s připojovacím napětím rozvaděče.
5. Délky vodičů snímačů/servomotorů, 24V-řídících vedení max. 50m neukládat společně s 230/400V vedeními nebo použít stíněné kabely
6. Uvedené průřezy vedení jsou minimální průřezy měděných vodičů bez zohlednění délky kabelů a stavebních podmínek. Typy kabelů zvolte v závislosti na směrování.
7. K zajištění protimrazové ochrany zařízení se hlavní vypínač Q1 nesmí vypnout.
8. Proudové chrániče RCD jsou povoleny pouze jako všeproudové chrániče typu B s 300 mA.



	jednotka	CFL-32 PWW, PKW	62-34-030-001	=	+
datum	05.04.2017				
zprac.	Kur				
přezkouš					
vznik	62-34-030-001				
jméno		nahrazen			
datum		nahrazen			

	POKYNY K UVEDENÍ DO PROVOZU	62-34-030-001	=	+
Odd.: TR	EP/AN P8 2.6.3	Art.Nr. 3065175_CZ		
list od 15 listy				

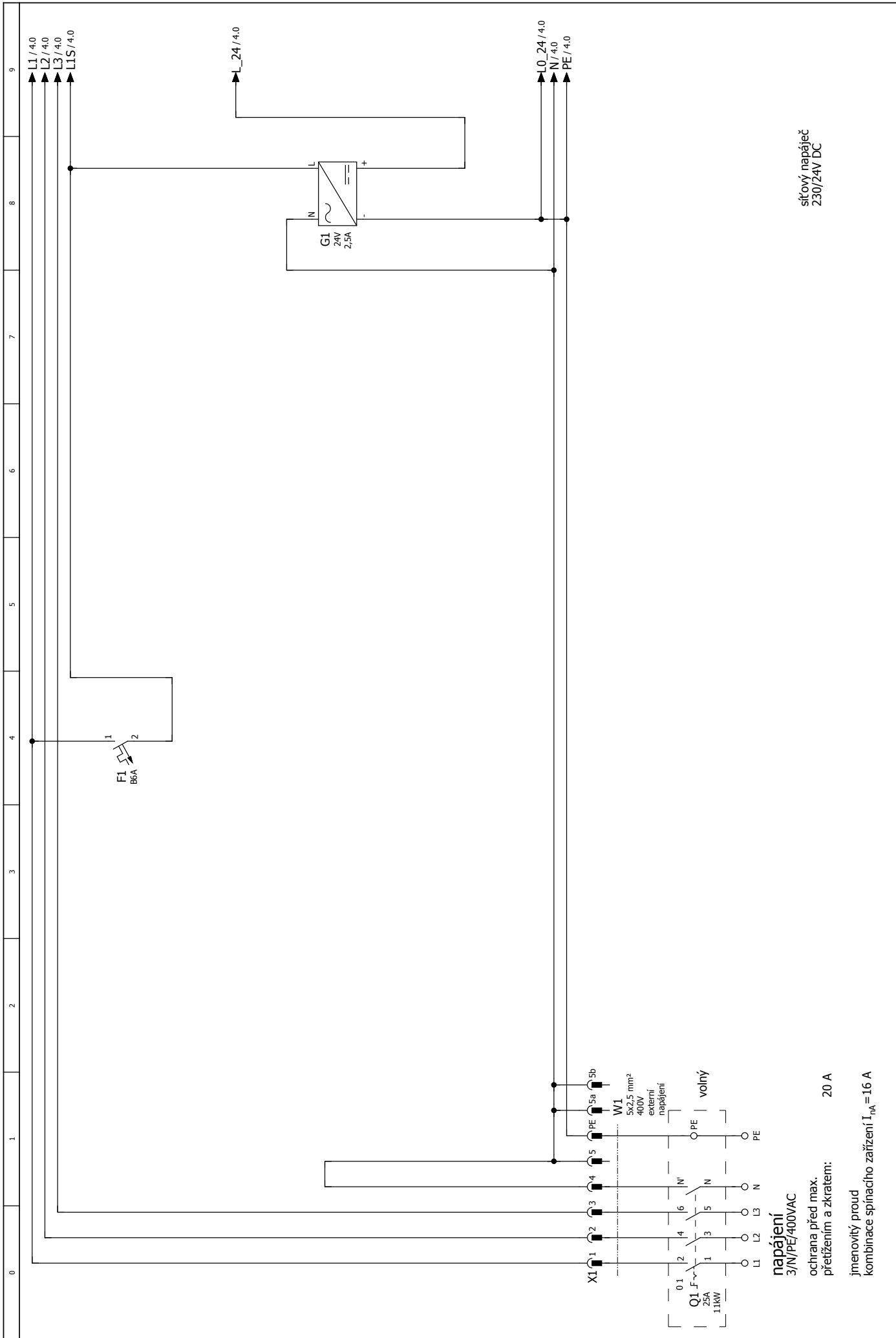

síťový napáječ
230/24V DC

napájení
3/N/PE/400VAC

ochrana před max.
přetížením a zkratem: 20 A

jmenovitý proud
kombinace spínacího zařízení I_{NA} = 16 A

				WOLF		NAPÁJENÍ HLAVNÍ VYPÍNAČ ŘÍDÍCÍ TRAFO		62-34-030-001		= +	
						jednotka CFL-32 PKW, PKW				EPLAN P8 2.6.3	
						nahrazen				Art.Nr. 3065175_CZ	
						nahrazen				libř od 15 listů	
změna				datum		jméno		vznik		62-34-030-001	
datum				05.04.2017		Kür		CFI-32 PKW, PKW		3	
zprac.						nahrazen		CFI-32 PKW, PKW		15 listů	
prezkoisř						nahrazen		62-34-030-001		15 listů	
vznik						nahrazen		62-34-030-001		15 listů	

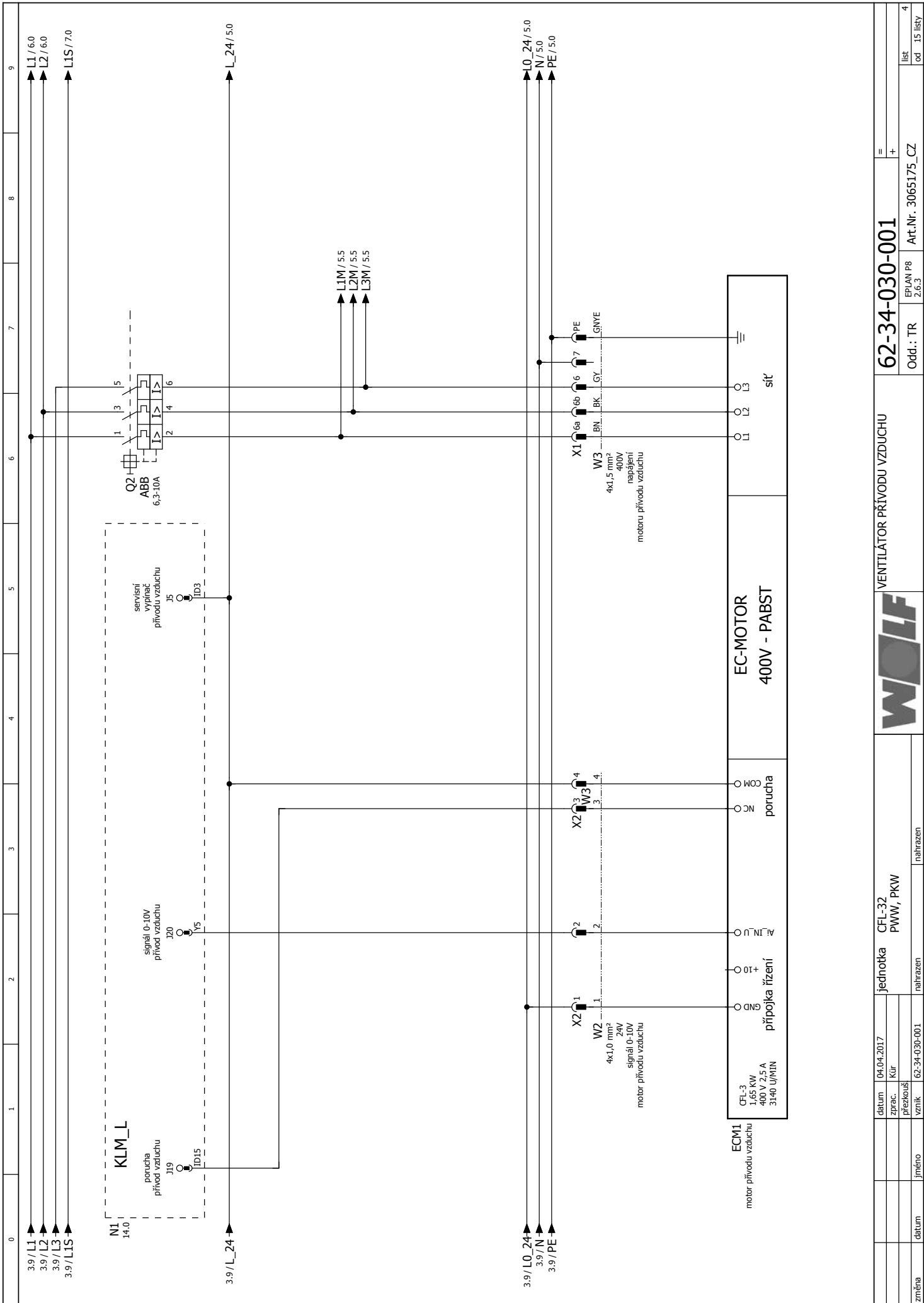

změna	datum	jméno	vznik	62-34-030-001	nahrazen	jednotka	CFL-32 PWW, PKW	nahrazen	VENTILÁTOR PŘÍVODU VZDUCHU	62-34-030-001	EP/AN P8 2.6.3	Art.Nr. 3065175_CZ	list od 15 listy

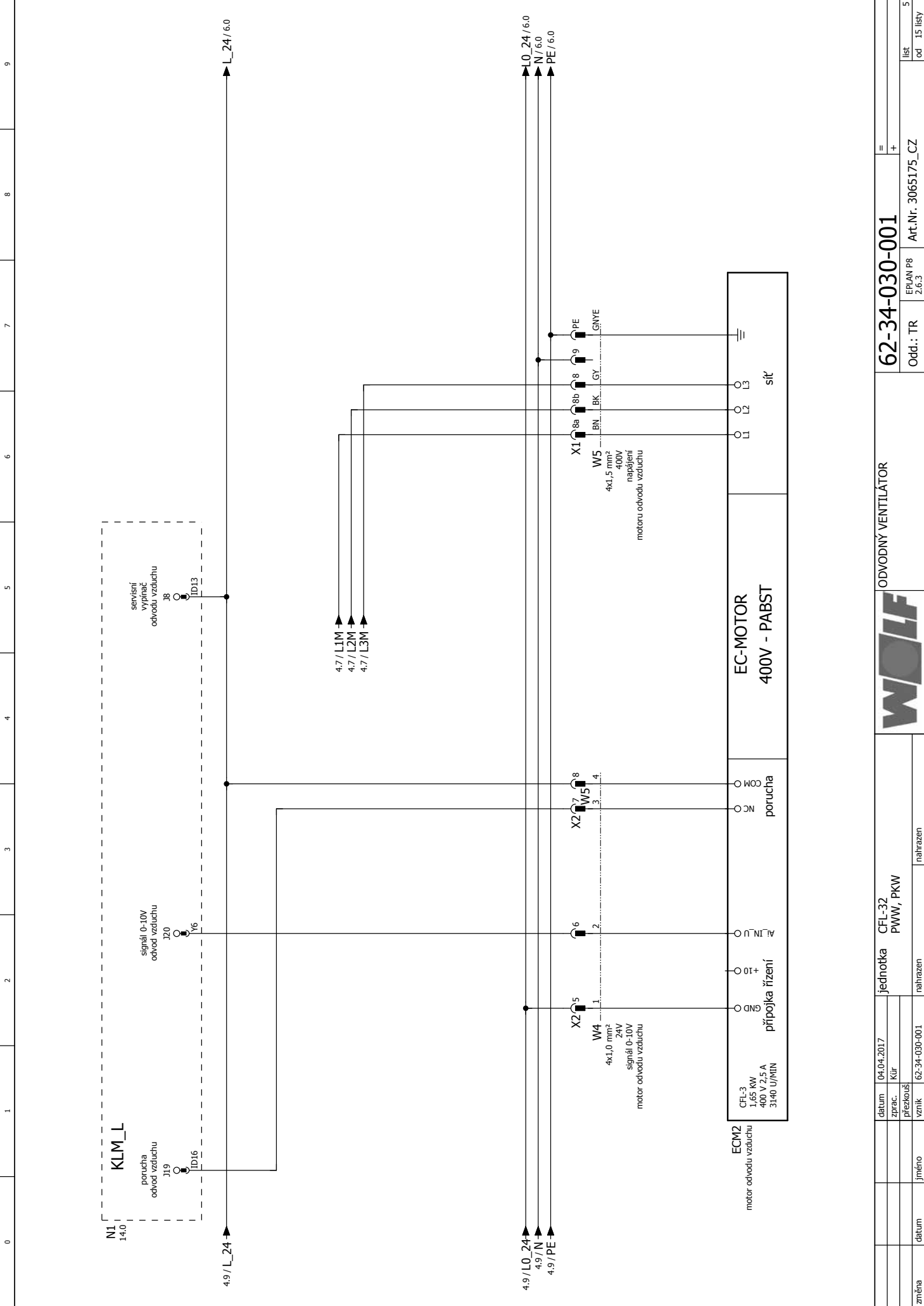

datum		04.04.2017		jednotka		CFE-32		ODVODNÝ VENTILÁTOR		62-34-030-001		=	
zprac.		Kür		PMMW, PKW		+		EPLAN P8		Art.Nr. 3065175_CZ		lit	
datum		62-34-030-001		nahrazen		nahrazen		2.6.3		Odd.: TR		od 15 listy	
změna		jméno		vznik		vznik		vznik		vznik		vznik	



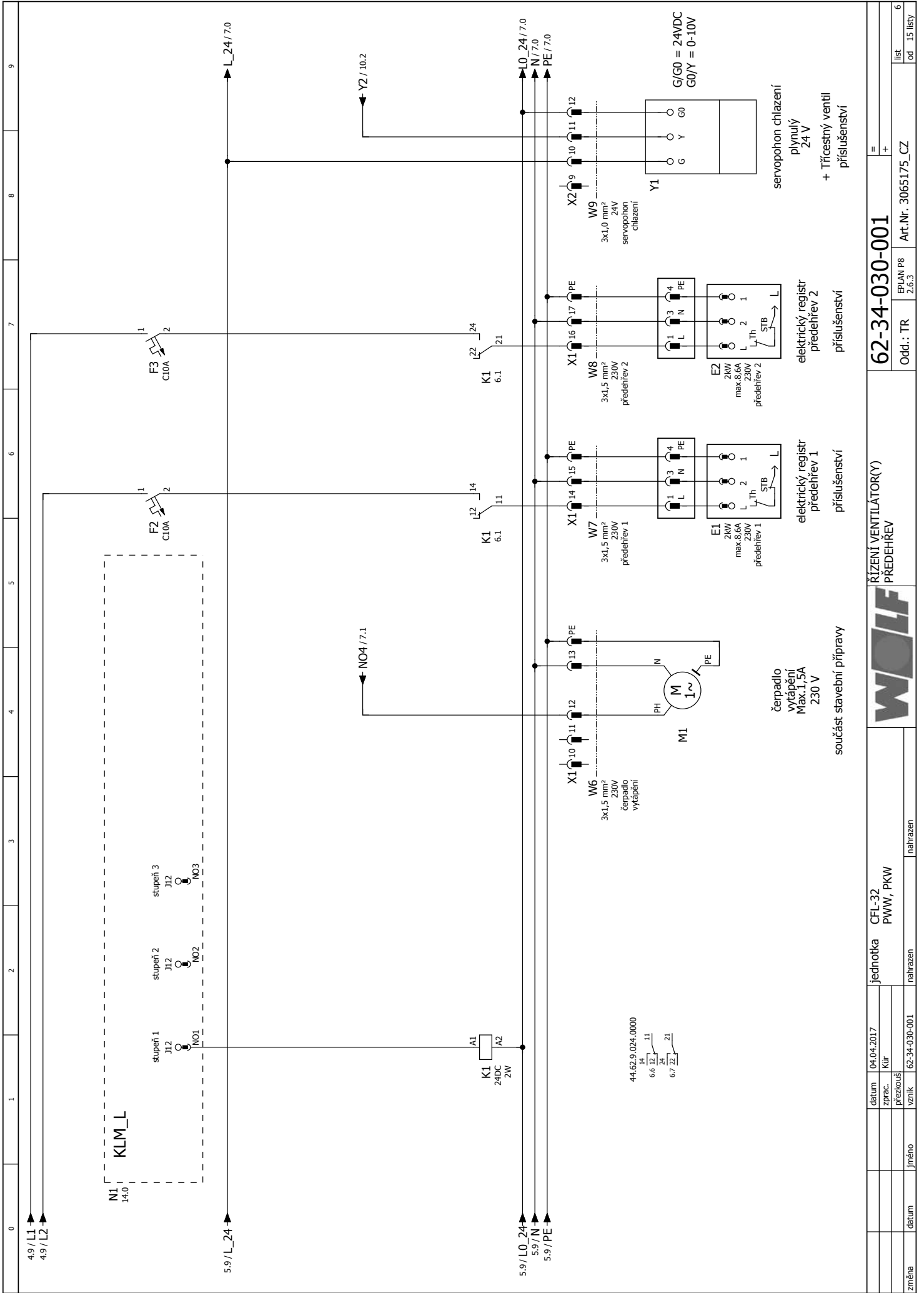

řídící ventilátor(y) PŘEDĚHEV	CFL-32 PWW, PKW	nahrazen	nahrazen
datum 04.04.2017	jednotka		
zprac. Kur			
přezkouš			
vznik	62-34-030-001		
jméno			
datum			
změna			

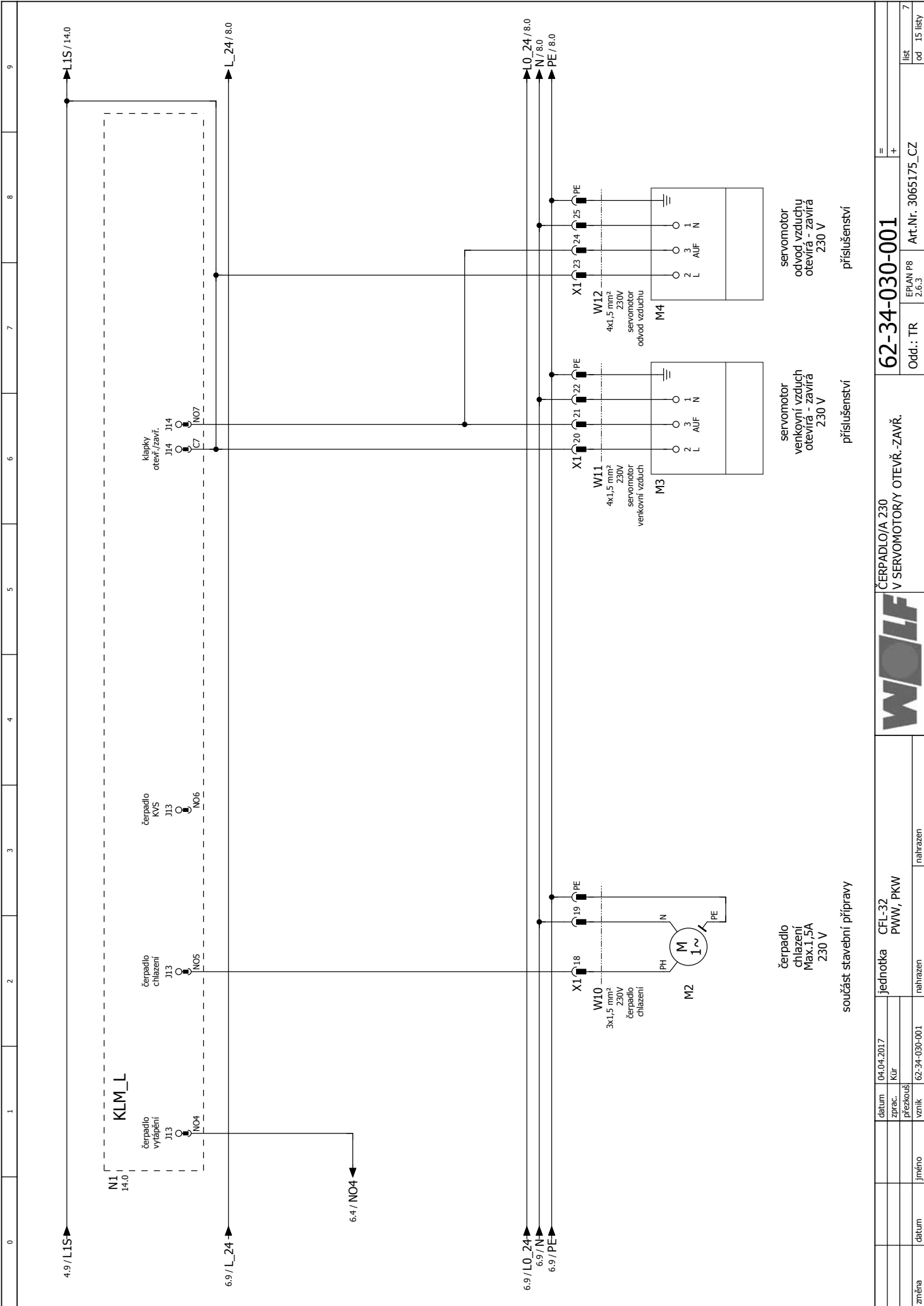

čerpadlo chlazení
Max.1.5A
230 V

součást stavební přípravy

servomotor venkovní vzduch otevířř - zavířř
230 V

příslušeství

servomotor odvod vzduchu otevířř - zavířř
230 V

příslušeství

datum		04.04.2017	jednotka		CFL-32
zprac.		Křř	číslo		PWW, PKW
přezkoušř			nahrazen		nahrazen
vznřk		62-34-030-001	nahrazen		nahrazen
změna	datum	jměno			
WOLF					
ČERPADLOVA 230 V SERVOMOTORY OTEVŘŘ-ZAVŘŘ.					
62-34-030-001					
Add.: TR EPLAN P8 2.6.3				Art.Nr. 3065175_CZ	
= +				libřt od 15 listř	

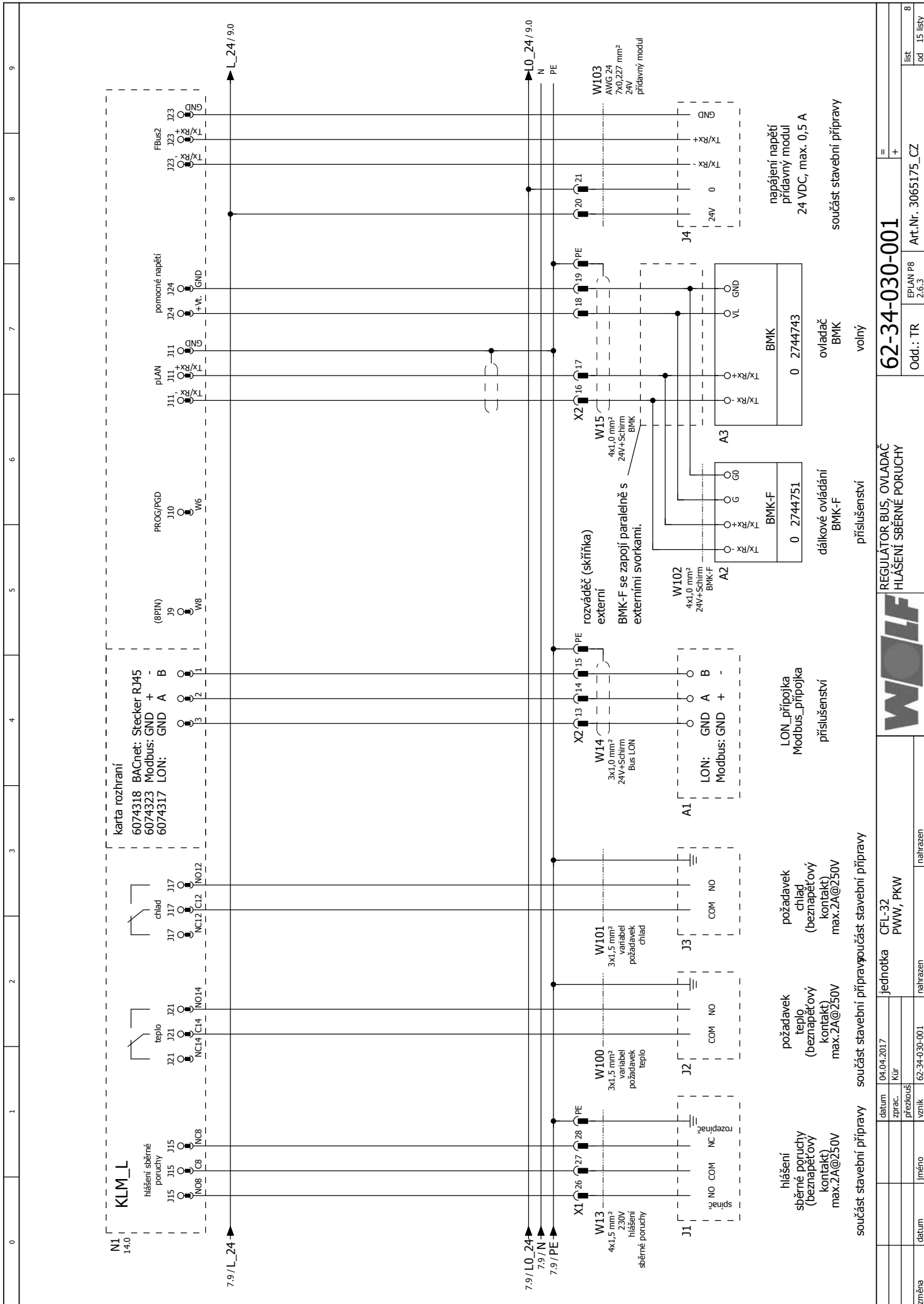

napájení napětí
přídavný modul
24 VDC, max. 0,5 A

ovladač
BMK
volný

dálkové ovládání
BMK-F
přisloušenství

LON přípojka
Modbus přípojka
přisloušenství

požadavek
chlád
(beznapětový
kontakt)
max.2A@250V

požadavek
teplo
(beznapětový
kontakt)
max.2A@250V

hlášení
sběrné poruchy
(beznapětový
kontakt)
max.2A@250V

součást stavební přípravy součást stavební přípravy součást stavební přípravy

REGULÁTOR BUS, OVLADAČ HLÁŠENÍ SBĚRNÉ PORUCHY		62-34-030-001		EP/JAN P8 2.6:3		Art.Nr. 3065175_CZ		list od 15 listy	
změna	datum	jméno	vznik	62-34-030-001	nahrazen	jednotka	CFL-32 PWW, PKW	nahrazen	
	datum		04.04.2017						
	zprac.		Kur						
	přezkouš.								

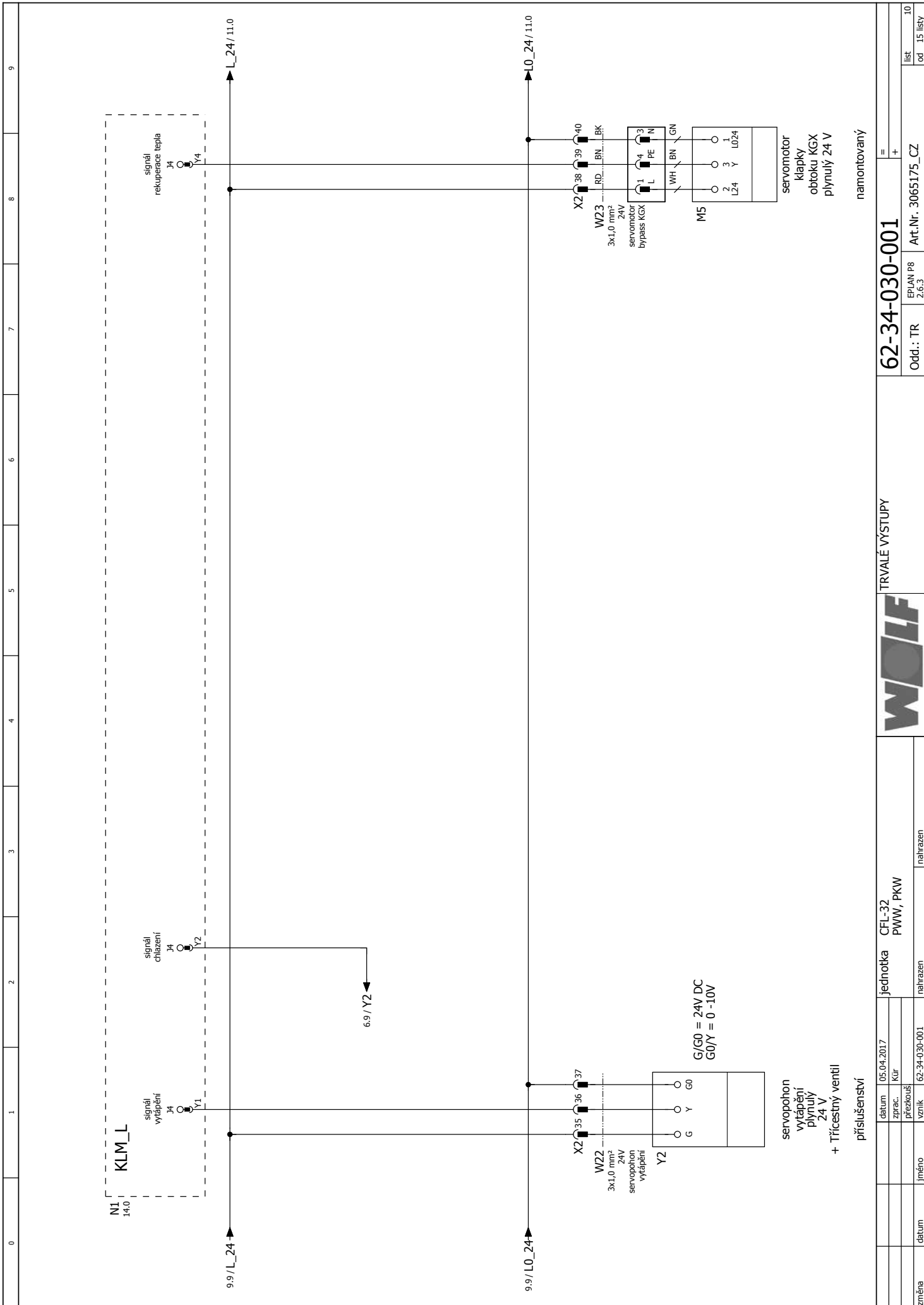

0		1		2		3		4		5		6		7		8		9	
WOLF																			
TRVALÉ VÝSTUPY										62-34-030-001									
jednotka CFL-32 PWW, PKW										Art.Nr. 3065175_CZ									
nahrazen										EP/JAN P8 2.6.3									
nahrazen										Oddl.: TR									
vznik 62-34-030-001										list 10									
datum 05.04.2017										od 15 listy									
zprac. Kur										=									
přezkouš										+									
jméno										namontovaný									
datum										servomotor klapky obtoku KGX plynů 24 V									
vznik 62-34-030-001										servomotor klapky obtoku KGX plynů 24 V									

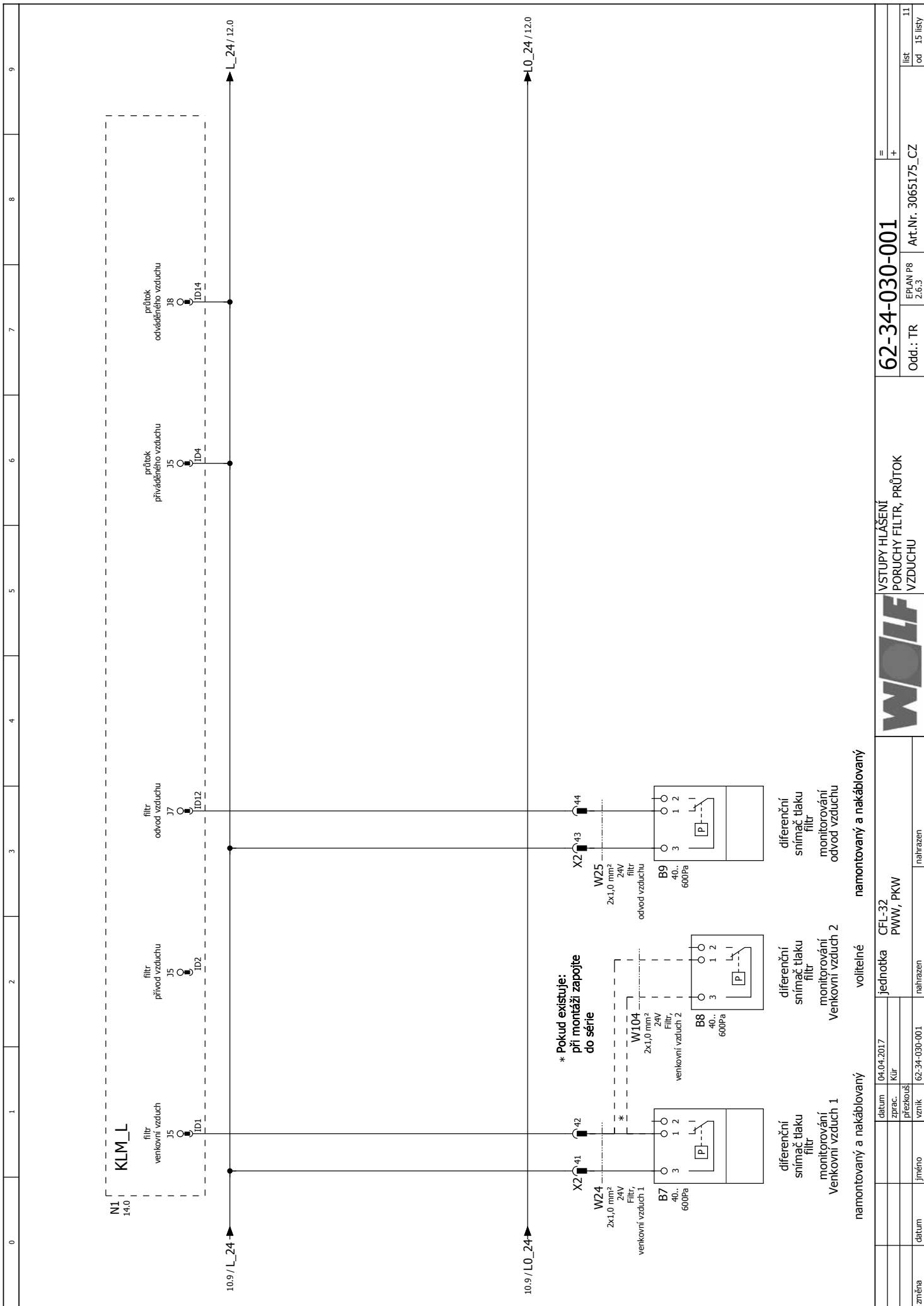

změna		datum	jméno	prezkois	62-34-030-001	nahrazen
datum		04.04.2017	Kür	CFL-32	PKW	nahrazen
jedinotka		volitelné				
namontovaný a nakáblovaný		namontovaný a nakáblovaný				
WOLF						
VSTUPY HLÁSENÍ PORUCHY FILTR, PRŮTOK VZDUCHU						
62-34-030-001				EPLAN P8 2.6.3	Art.Nr. 3065175_CZ	lit od 15 listy
=				+		

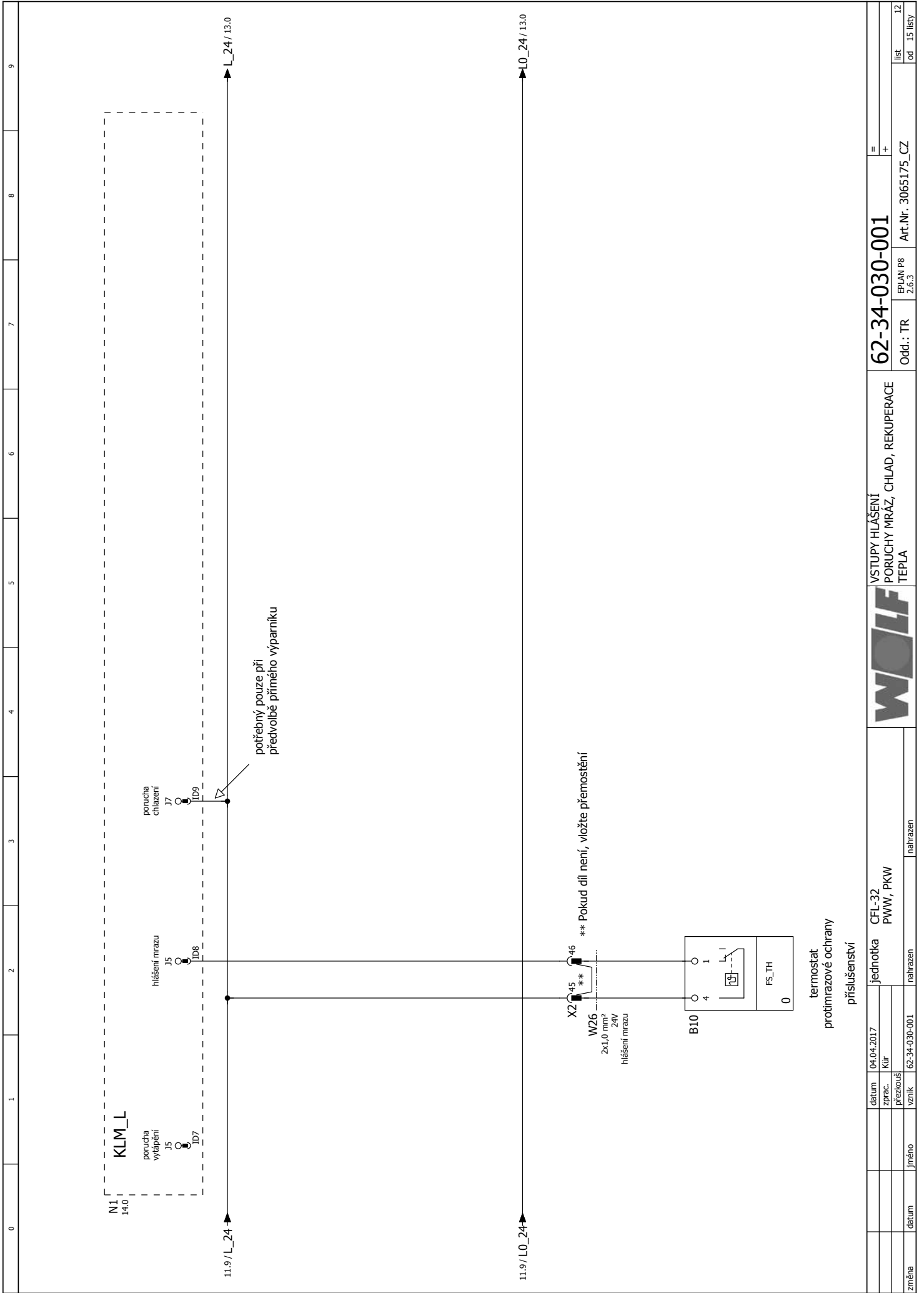

0	1	2	3	4	5	6	7	8	9
změna	datum	jméno	vznik	62-34-030-001	nahrazen	CFI-32 PWW, PKW	nahrazen	VSTUPY HLÁŠENÍ PORUCHY MRÁZ, CHLAD, REKUPERACE TEPLA	
	datum	04.04.2017	zprac.	Kur				62-34-030-001	
	datum		zprac.					=	
	datum		zprac.					+	
	datum		zprac.					EP/JAN P8	
	datum		zprac.					2.6.3	
	datum		zprac.					Oddl.: TR	
	datum		zprac.					Art.Nr. 3065175_CZ	
	datum		zprac.					=	
	datum		zprac.					+	
	datum		zprac.					list	
	datum		zprac.					od 15 listy	

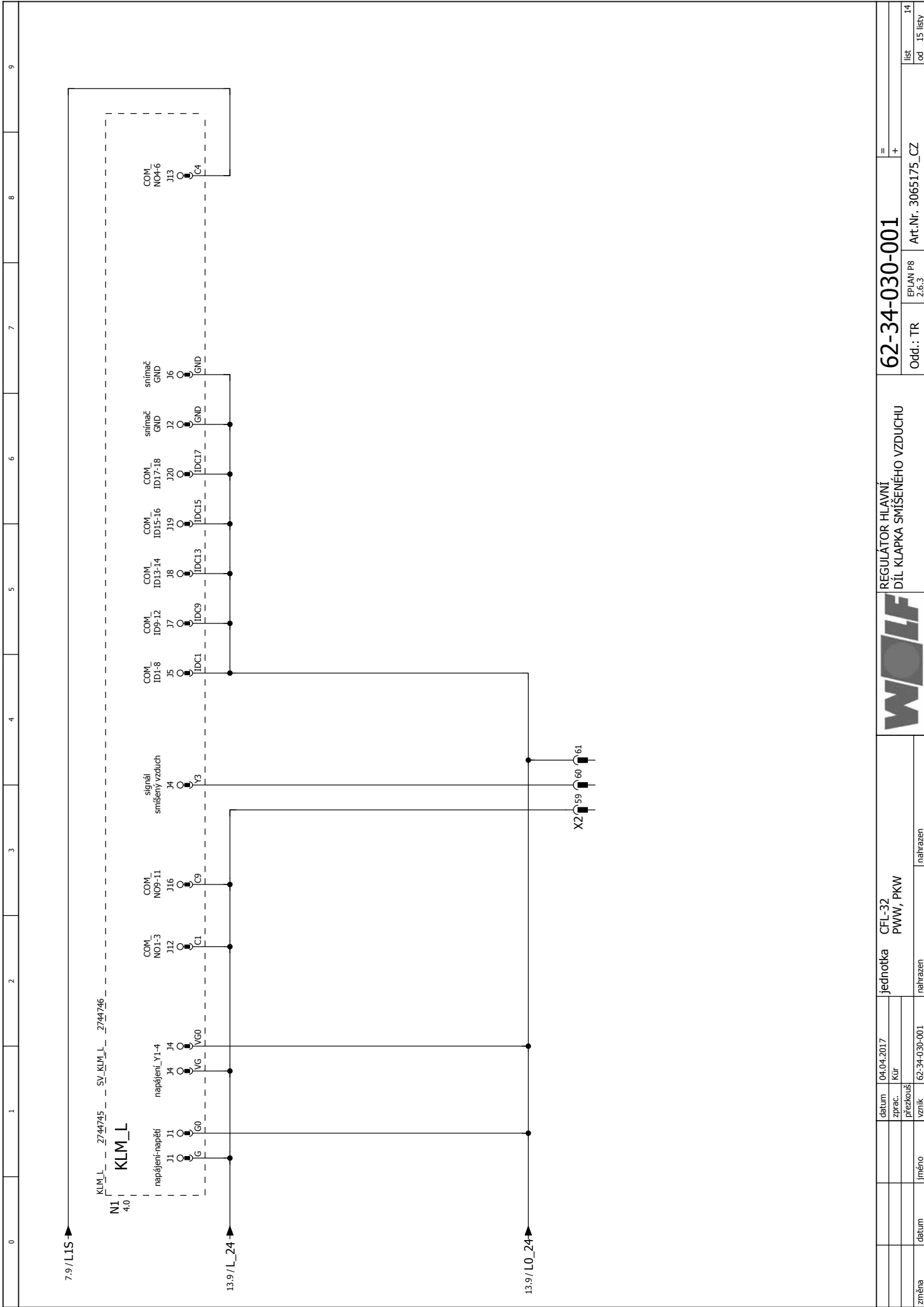

změna		datum	jméno	vznik	62-34-030-001	nahrazen	jednotka		CFL-32 PWW, PKW	REGULÁTOR HLAVNÍ DÍL KLAPKA SMÍŠENÉHO VZDUCHU		62-34-030-001	EP/JAN P8 2.6.3	Art.Nr. 3065175_CZ	list od 14	15 listy
datum		04.04.2017														
zprac.		Kur														
přezkouš.																
datum																

